

**Detail Issued For Guidance Only,
Designer's Approval Required**

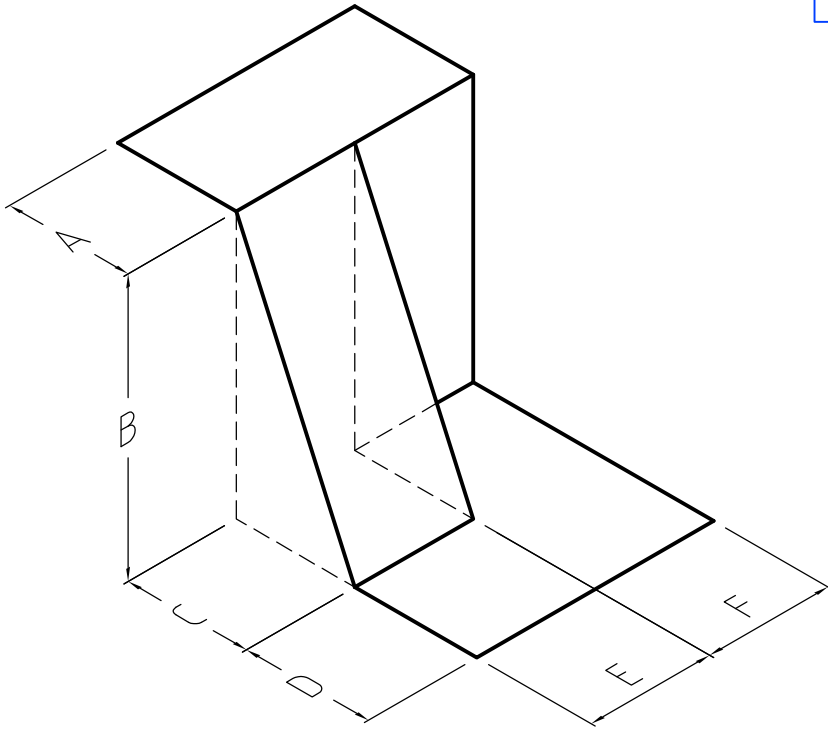

Jamb Cloak (Built-in) :	
A	
B	
C	
D	
E	
F	
Quantity As	
Quantity Opp.	

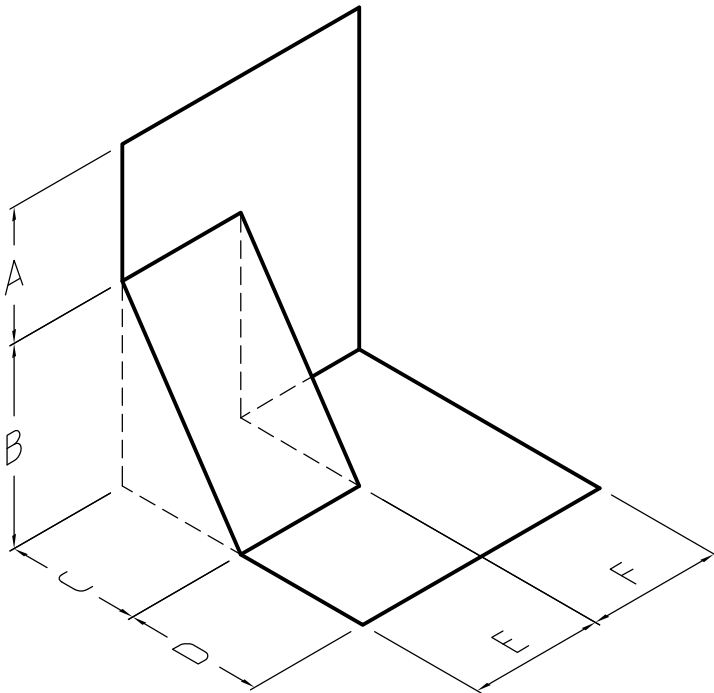

Jamb Cloak (Surface fixed) :	
A	
B	
C	
D	
E	
F	
Quantity As	
Quantity Opp.	

Zedex	
Ultimate	

NB; DO NOT SCALE - USE FIGURED DIMENSIONS ONLY.



Visqueen
Contact Technical Support :
 t : 0333 202 6800
 f : 0333 202 6886
 e : enquiries@visqueen.com
 www.visqueen.com

Project: Standard Detail : Preformed Jamb Cloaks.

Drawing No.- PFU-516.

Date.- 12/18.

Scale.- NTS.

© COPYRIGHT RESERVED.