

1
Install blinding layer. Prime steel column with Visqueen HP Tanking Primer min 150mm vertically.

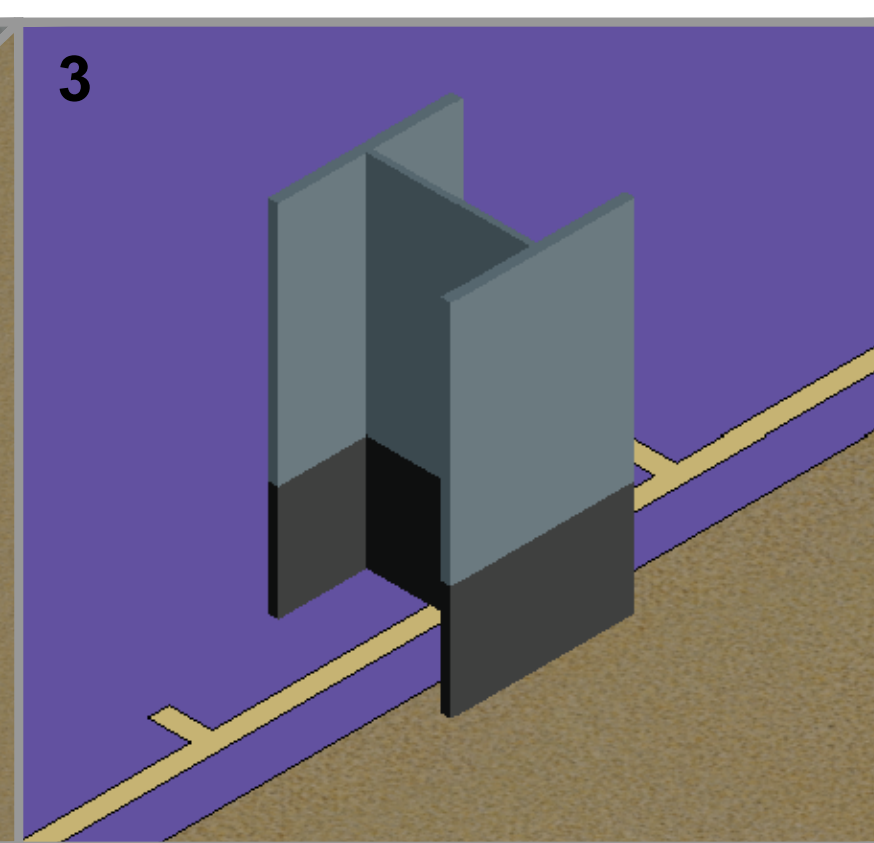

3
Cut and install Visqueen Ultimate RadonBlok 600 around column. Apply Visqueen Ultimate RadonBlok Double Sided Tape.

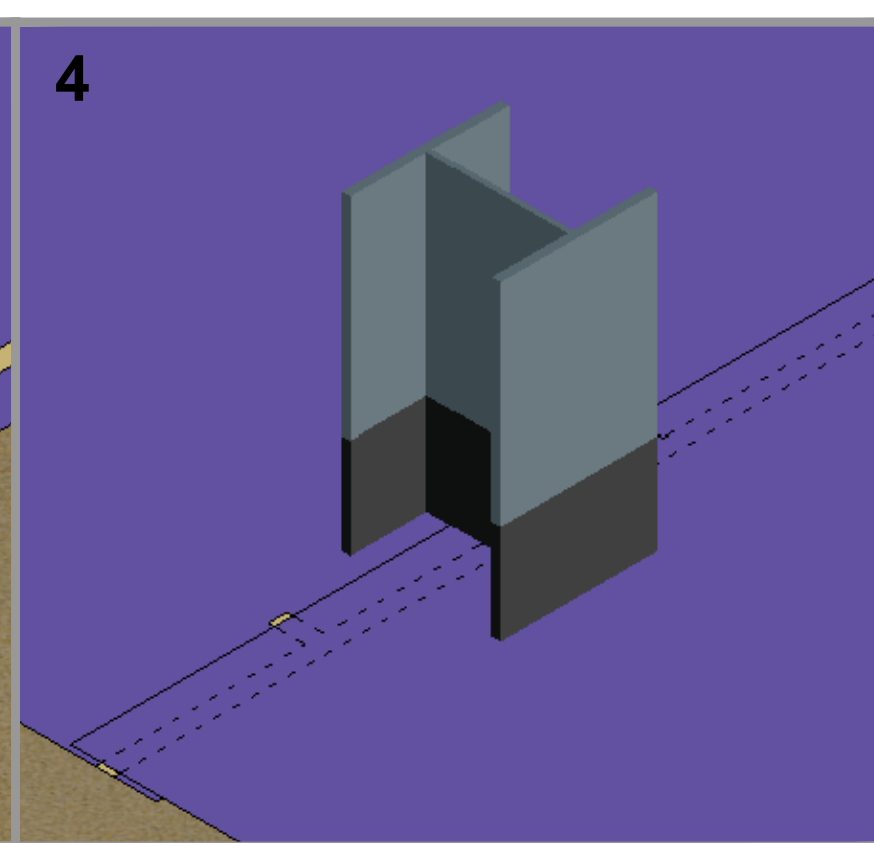

4
Cut and install adjacent membrane around column, bonding to Visqueen Ultimate RadonBlok Double Sided Tape.

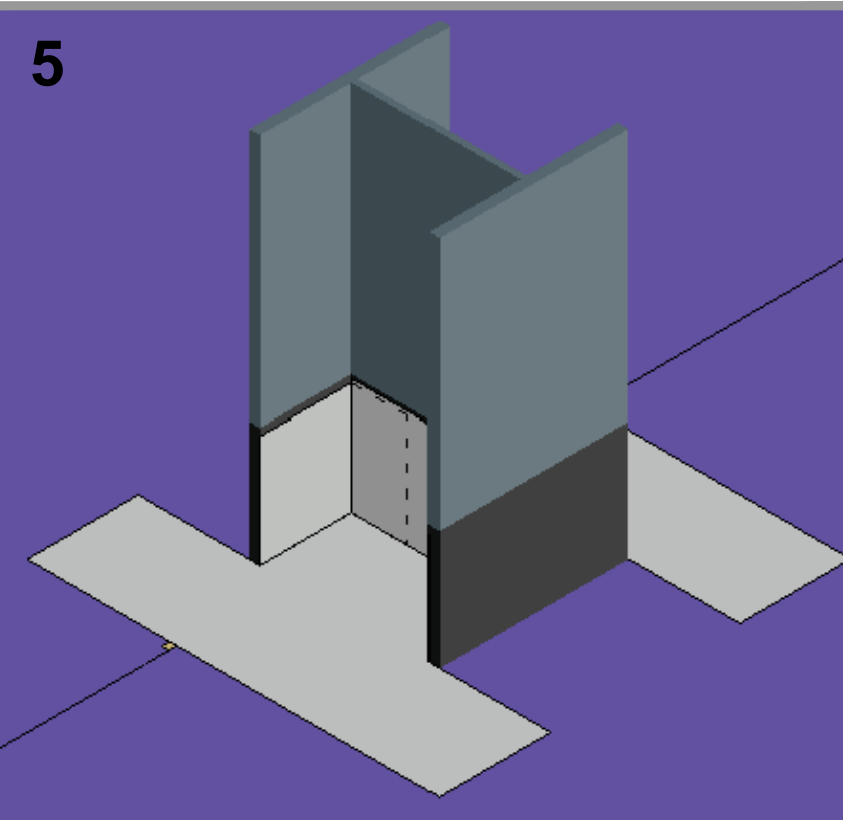

5
Bond VisqueenPro Detailing Strip to column web and membrane, extending min 150mm up column and onto membrane.

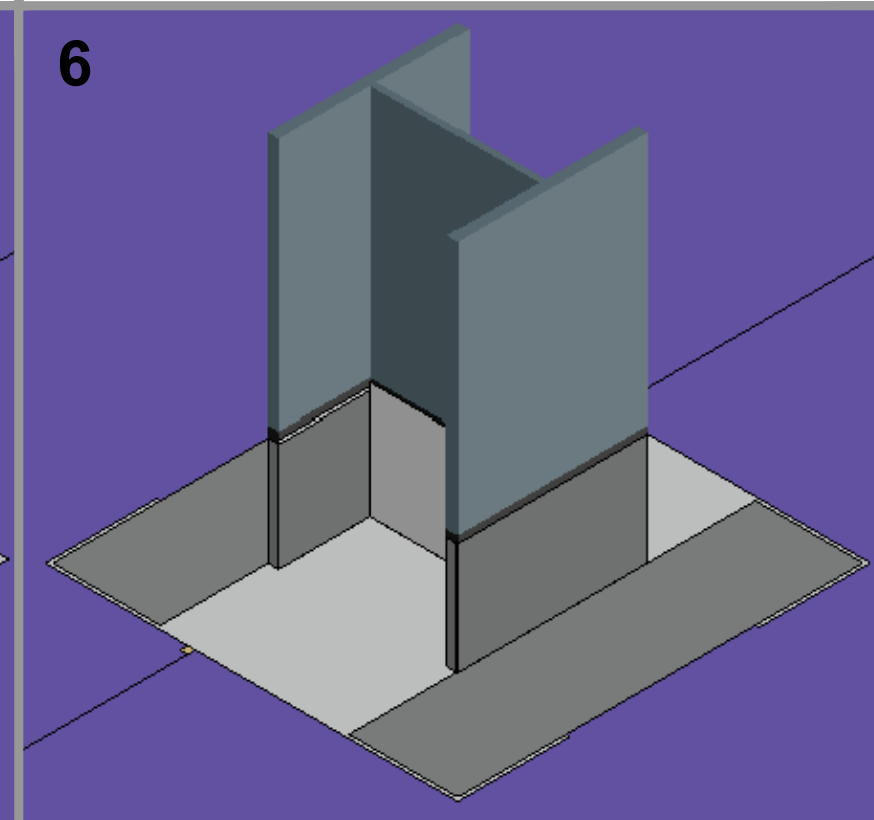

6
Bond additional detailing strip to column flange and membrane, extending min 150mm up column, onto membrane and detailing strip from previous step.

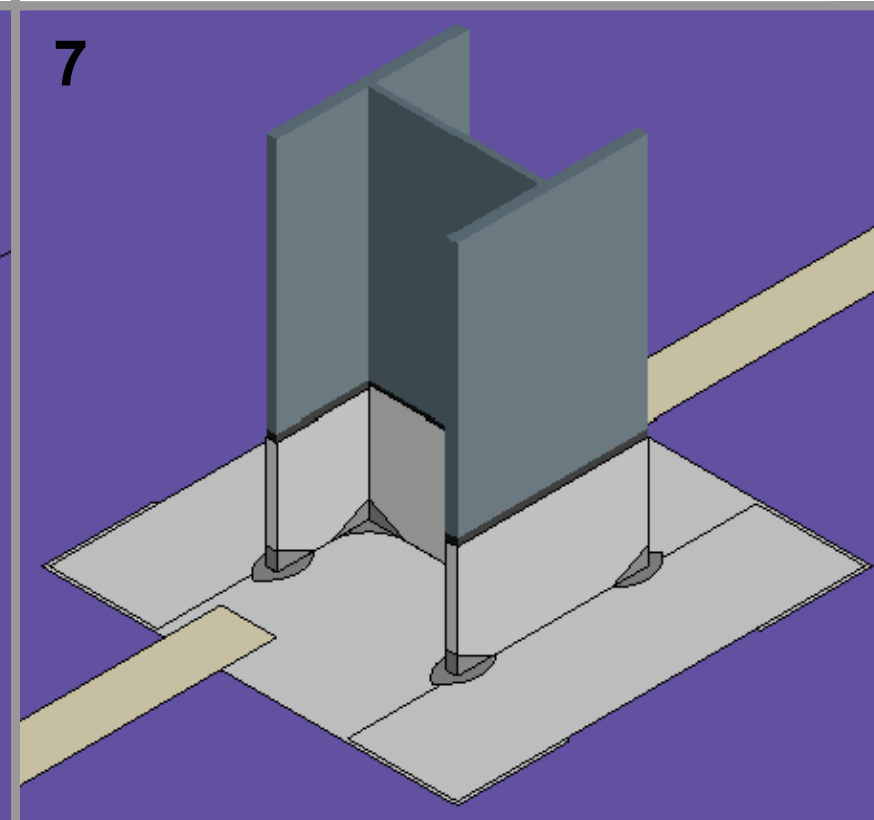

7
Cut detailing strip into triangular pieces and bond to corners. Bond VisqueenPro Single Sided Tape over membrane lap and min 75mm onto detailing strip.

CRITICAL GUIDANCE NOTES

Visqueen Guidance Details are for illustration purposes only. It is the lead designer's responsibility to ensure Guidance Details are incorporated correctly into construction drawings.

Visqueen take no project design liability, or responsibility for the use of Guidance Details. Visqueen have no control over the situation in which the products are installed. Visqueen provide a Contract Design Service where project specific drawings can be produced. Contact Visqueen Technical Services for further information.

Site construction sequencing should be assessed before the appropriate Guidance Detail is selected and approved by the lead designer.

Designer/contractor to ensure that all stakeholders accept the approach shown in this Guidance Detail prior to implementation on site.

All Visqueen materials must be installed in strict accordance with the Visqueen product datasheets and applicable 3rd party certificates.

Radon protection in accordance with national building regulations and BR211:2023.

Each stage of the VisqueenPro Detailing Strip installation to be rolled to ensure a full bond is achieved.

Visqueen TreadGUARD protection layer above membrane required as per specification.

Drawing not to scale, use figured dimensions only. All figured dimensions are in millimetres.

The information in this Guidance Detail was correct at the time of publication. It is the user's responsibility to obtain the latest revision which supersedes all previously published revisions.

Guidance Detail

Date: November 2023

Drawing No: URB600-82

Revision: A Drawn by: JR

Approved by: SD



STEEL COLUMN DETAILING USING VISQUEENPRO DETAILING STRIP STEP BY STEP

Tel: 0333 202 6800
 enquiries@visqueen.com
 www.visqueen.com

© Copyright reserved. This drawing may not be reproduced or amended without prior written permission.